



U128PC

Vanity Mounted Soap Dispenser

Revision 04/11

JOB #:

ITEM #:

QUANTITY:

MOUNTING	HANDING	TYPE	SIZE	OTHER

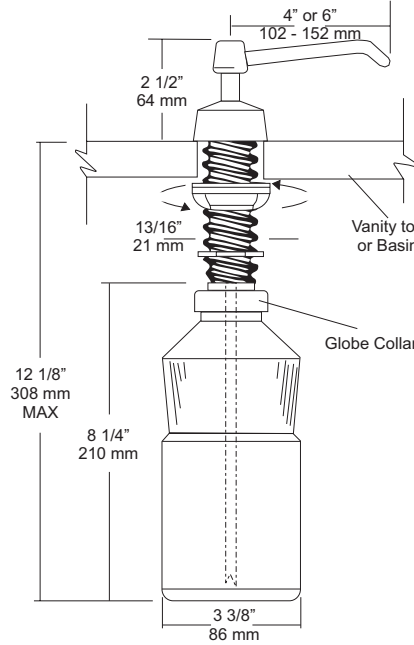

SPECIFICATIONS

Piston & Spout: Highly polished corrosion resistant, stainless steel. Assembly rotates 360 degrees.

Flange & Collar: One piece highly polished chrome on brass.

Valve Assembly: All purpose bellows valve, fabricated of ABS material, with stainless steel return spring.

Shank: Chrome on brass, secured to collar. Special key provided that unlocks collar for servicing.

Globe & Collar: High impact translucent polyethylene.

Capacity: 34 fl oz

U128PCA: Same as U128PC with 6" (152mm) spout.

Recommend type soaps without chloric solutions for proper operation.

***All vanity soap dispensers are designed to be serviced above the counter**

INSTALLATION

Provide a 7/8" - 1" diameter opening in vanity or basin. Insert shank through cut out and secure with supplied washers and wing nut. Connect supply tube with valve making sure notch end is at bottom. Secure globe and collar to shank. Fill globe above counter. Secure upper assembly to shank. Prime dispenser every time unit is serviced.

*It is not recommended to mount any soap dispenser on mirrors

**For best performance, use pre-mixed low concentrate solutions. Dispensers should have periodic maintenance performed to insure the life dispenser. Rinse out globe and valve with warm water to avoid sludge buildup.

Preventative Maintenance: Each dispenser should be flushed out aprx. Every 30 days with warm water to prevent valve from clogging with old soap. Do not use abrasive cleaners to clean dispenser.

NOTES

Formerly Model #: U128-PC